



PLASMA

PLASMA



KitWeld

www.kitweld.com



LT-50



L-70



LT-100



LT-150



LTM-70



LTM-150



NEW
MECHANICAL
SAFETY DEVICE



LTM-81



LTM-101



LT-81



LT-101



LT-141



LTM-141



LTM-151



LT-151

RWJ
DIŞ TİCARET VE SANAYİ LTD. ŞTİ.

Adres: Ahi Evran Caddesi No:30
Ostim - Ankara - TÜRKİYE
Tel : +90 312 3850080 Fax: +90 312 3850089
E-mail: bilgi@kitweld.com

RMT LTD is in no way affiliated with CEBORA® and TRAFIMET®. The parts advertised for sale are not genuine CEBORA® and TRAFIMET® parts, but are parts made for RMT LTD. Reference to CEBORA® and TRAFIMET® torches and numbers are for your convenience only. We reserve the right to substitute genuine CEBORA® and TRAFIMET® part in place of Kitweld parts.

with high frequency

with high frequency



IEC 60974-7

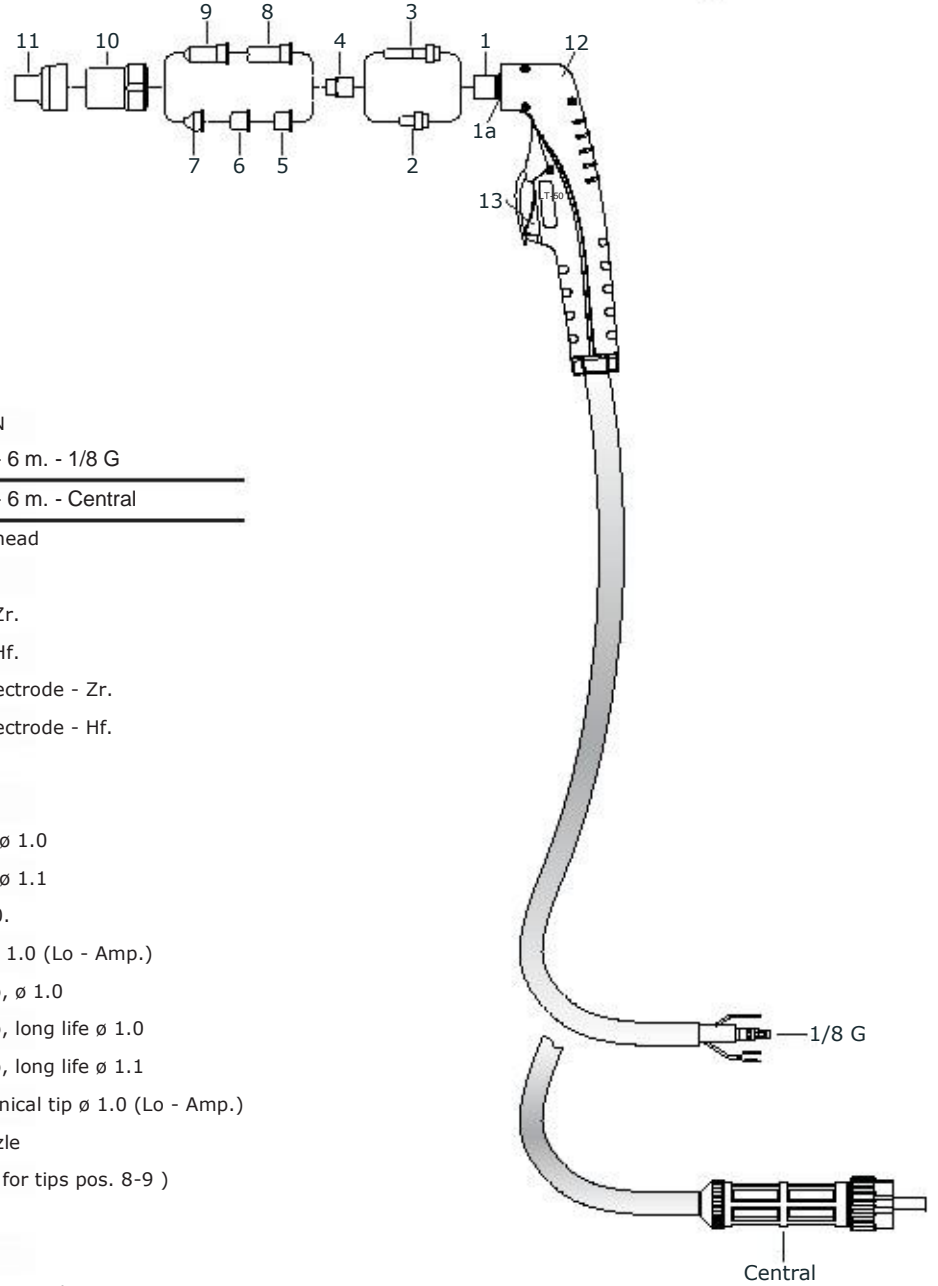

ITEM	REF.	CODE	DESCRIPTION
	1526	T3544116	Hand torch - 6 m. - 1/8 G
	1574	T3544117	Hand torch - 6 m. - Central
1		R2719108	Hand torch head
1a		R2729101	O-Ring
2	1521-Zr	R2724101	Electrode - Zr.
	1521-Hf	R2724102	Electrode - Hf.
3	1518-Zr	R2724103	Extended electrode - Zr.
	1518-Hf	R2724104	Extended electrode - Hf.
4		R2722101	Swirl ring
5	1304	R2713101	Tip ϕ 1.0
	1396	R2713102	Tip long life ϕ 1.0
		R2713103	Tip long life ϕ 1.1
6		R2713104	Flat tip ϕ 1.0.
7	1305	R2713105	Conical tip ϕ 1.0 (Lo - Amp.)
8	1370	R2713106	Extended tip, ϕ 1.0
	1395	R2713107	Extended tip, long life ϕ 1.0
		R2713108	Extended tip, long life ϕ 1.1
9	1306	R2713109	Extended conical tip ϕ 1.0 (Lo - Amp.)
10	5.710.121	R2712101	Outside nozzle
11		R2723101	Shield cup (for tips pos. 8-9)
12		R2730104	Handle
13		R4932102	Trigger
14		R2716101	Circle cutting attachment

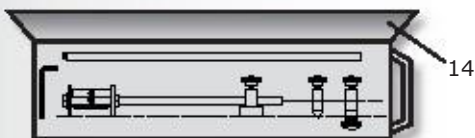

RMT Ltd. is in no way affiliated with CEBORA®. The parts advertised for sale are not genuine CEBORA® parts, but are parts made for RMT Ltd. Reference to CEBORA® torches and numbers are for your convenience only. We reserve the right to substitute genuine CEBORA® parts in place of RMT Ltd. parts.



IEC 60974-7

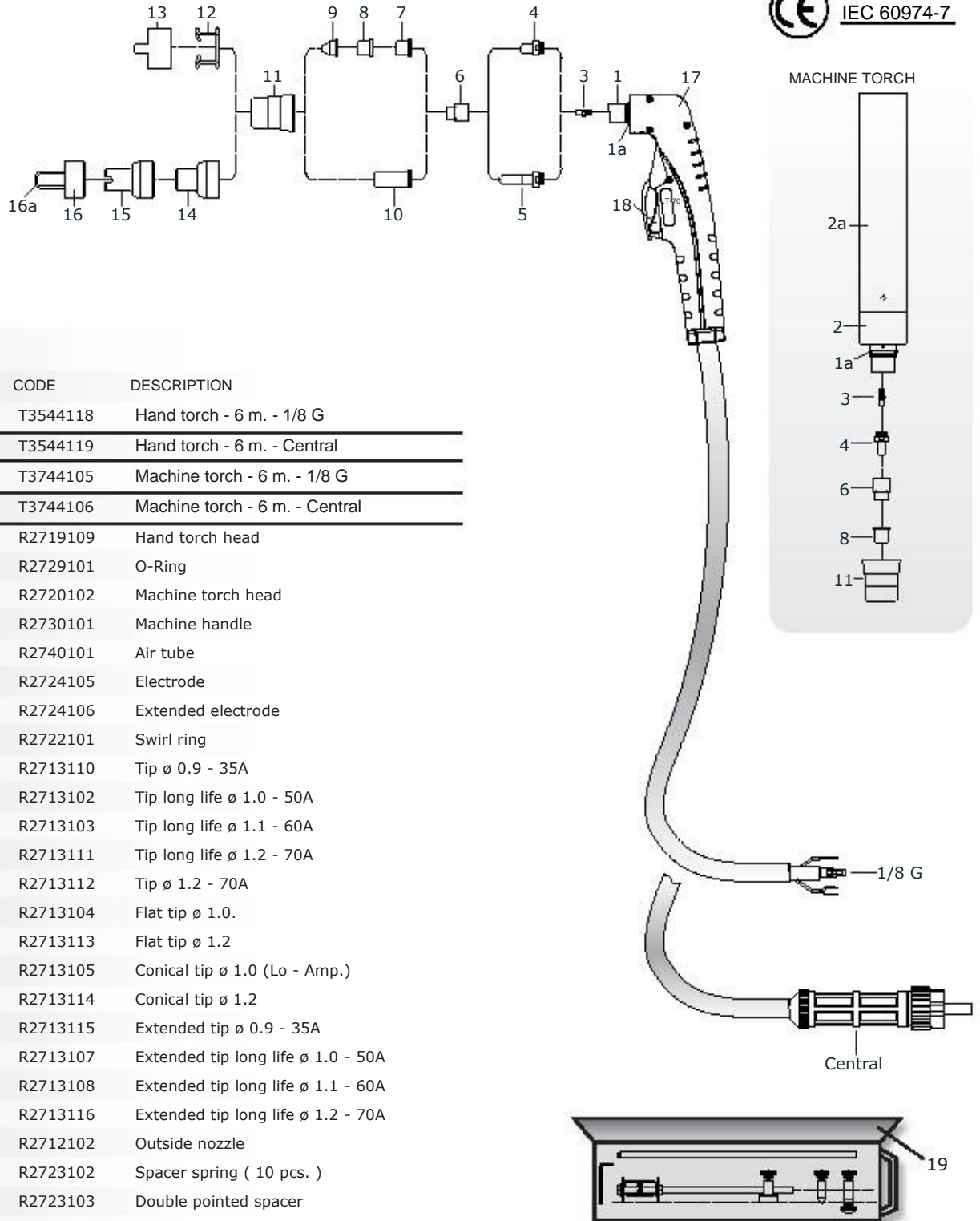

ITEM	REF.	CODE	DESCRIPTION
	1564	T3544118	Hand torch - 6 m. - 1/8 G
	1573	T3544119	Hand torch - 6 m. - Central
	1563	T3744105	Machine torch - 6 m. - 1/8 G
	1566	T3744106	Machine torch - 6 m. - Central
1		R2719109	Hand torch head
1a	3.160067	R2729101	O-Ring
2	1349	R2720102	Machine torch head
2a	3.055.623	R2730101	Machine handle
3	3.065.204	R2740101	Air tube
4	1402	R2724105	Electrode
5	1368	R2724106	Extended electrode
6		R2722101	Swirl ring
7	1309	R2713110	Tip ϕ 0.9 - 35A
	1396	R2713102	Tip long life ϕ 1.0 - 50A
		R2713103	Tip long life ϕ 1.1 - 60A
		R2713111	Tip long life ϕ 1.2 - 70A
	1308	R2713112	Tip ϕ 1.2 - 70A
8		R2713104	Flat tip ϕ 1.0.
		R2713113	Flat tip ϕ 1.2
9	1305	R2713105	Conical tip ϕ 1.0 (Lo - Amp.)
		R2713114	Conical tip ϕ 1.2
10	1366	R2713115	Extended tip ϕ 0.9 - 35A
	1395	R2713107	Extended tip long life ϕ 1.0 - 50A
		R2713108	Extended tip long life ϕ 1.1 - 60A
		R2713116	Extended tip long life ϕ 1.2 - 70A
11	5.710.171	R2712102	Outside nozzle
12	1394	R2723102	Spacer spring (10 pcs.)
13	1405	R2723103	Double pointed spacer
14		R2723104	Spacer (for tips pos. 10)
15		R2723105	Spacer (for tips pos. 10)
16		R2723106	Spacer with springs (for tips pos. 10)
16a		R2723107	Spring (20 pcs.)
17	R2730104	R2730104	Handle
18	R4932102	R4932102	Trigger
19		R2716100	Circle cutting attachment

RMT Ltd. is in no way affiliated with CEBORA®. The parts advertised for sale are not genuine CEBORA® parts, but are parts made for RMT Ltd. Reference to CEBORA® torches and numbers are for your convenience only. We reserve the right to substitute genuine CEBORA® parts in place of RMT Ltd. parts.

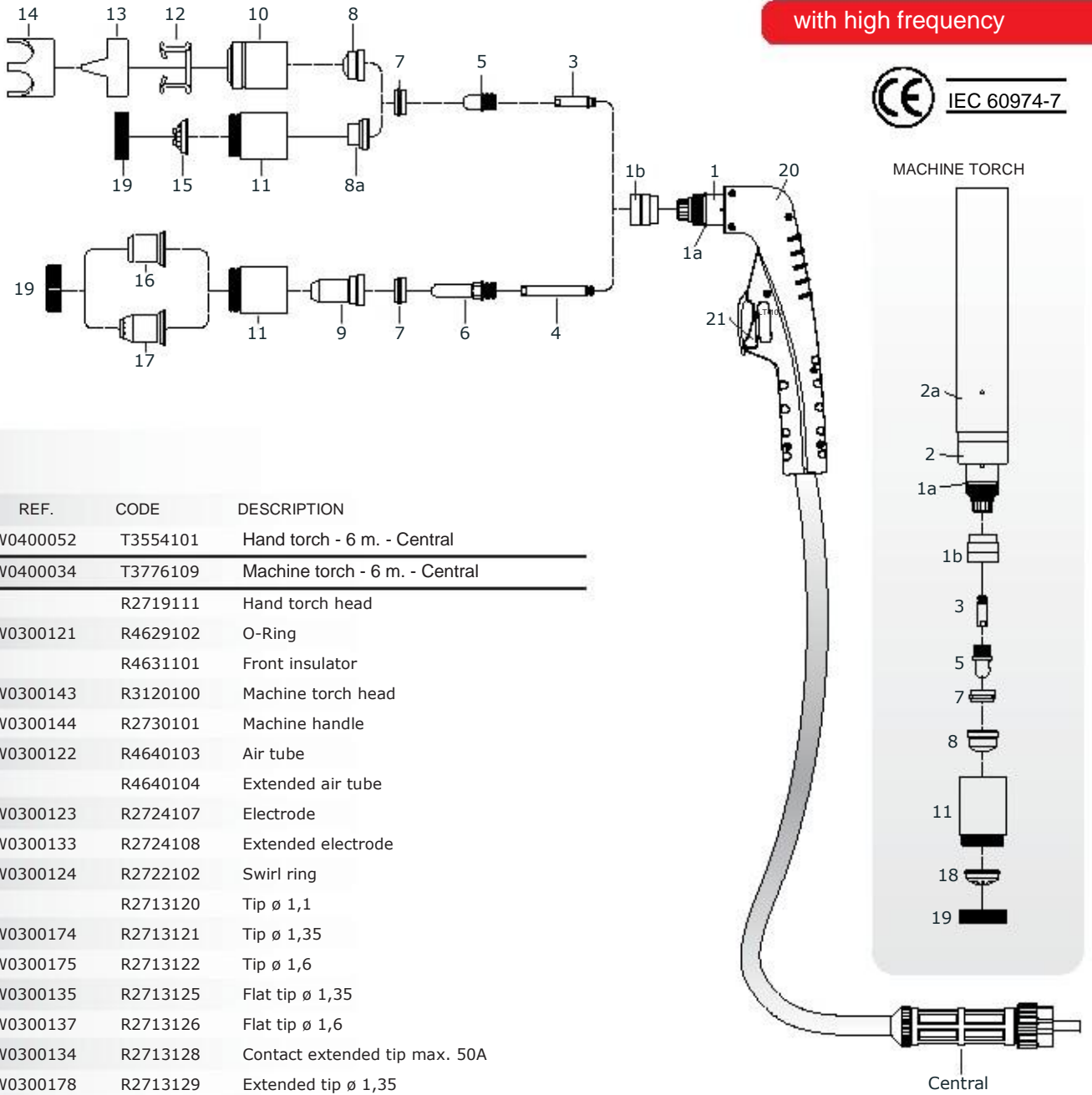

ITEM	REF.	CODE	DESCRIPTION
	W0400052	T3554101	Hand torch - 6 m. - Central
	W0400034	T3776109	Machine torch - 6 m. - Central
1		R2719111	Hand torch head
1a	W0300121	R4629102	O-Ring
1b		R4631101	Front insulator
2	W0300143	R3120100	Machine torch head
2a	W0300144	R2730101	Machine handle
3	W0300122	R4640103	Air tube
4		R4640104	Extended air tube
5	W0300123	R2724107	Electrode
6	W0300133	R2724108	Extended electrode
7	W0300124	R2722102	Swirl ring
8		R2713120	Tip \varnothing 1,1
	W0300174	R2713121	Tip \varnothing 1,35
	W0300175	R2713122	Tip \varnothing 1,6
8a	W0300135	R2713125	Flat tip \varnothing 1,35
	W0300137	R2713126	Flat tip \varnothing 1,6
9	W0300134	R2713128	Contact extended tip max. 50A
	W0300178	R2713129	Extended tip \varnothing 1,35
	W0300179	R2713130	Extended tip \varnothing 1,6
10	W0300129	R3112100	Outside nozzle
11	W0300138	R3112101	Contact cutting nozzle
		R3112103	Contact cutting nozzle, Max.life
12	W0300130	R2723125	Spacer spring (10 pcs.)
13	W0300131	R2723126	Double pointed spacer
14	W0300177	R2723127	Crown spacer
15	W0300180	R2723113	Spacer for contact cutting , hand
16	W0300182	R2723119	Shield cup, hand (max. 50A)
17	W0300183	R2723120	Spacer for contact cutting, hand
18	W0300181	R2723116	Shield cup, machine
19	W0300184	R2723122	Locking nut
20		R2730105	Handle
21		R4932102	Trigger
22		R4616102	Circle cutting attachment
	W0300142	R2740106	Extractor for swirl ring

RMT Ltd. is in no way affiliated with EWS®. The parts advertised for sale are not genuine EWS® parts, but are parts made for RMT Ltd. Reference to EWS® torches and numbers are for your convenience only. We reserve the right to substitute genuine EWS® parts in place of RMT Ltd. parts.

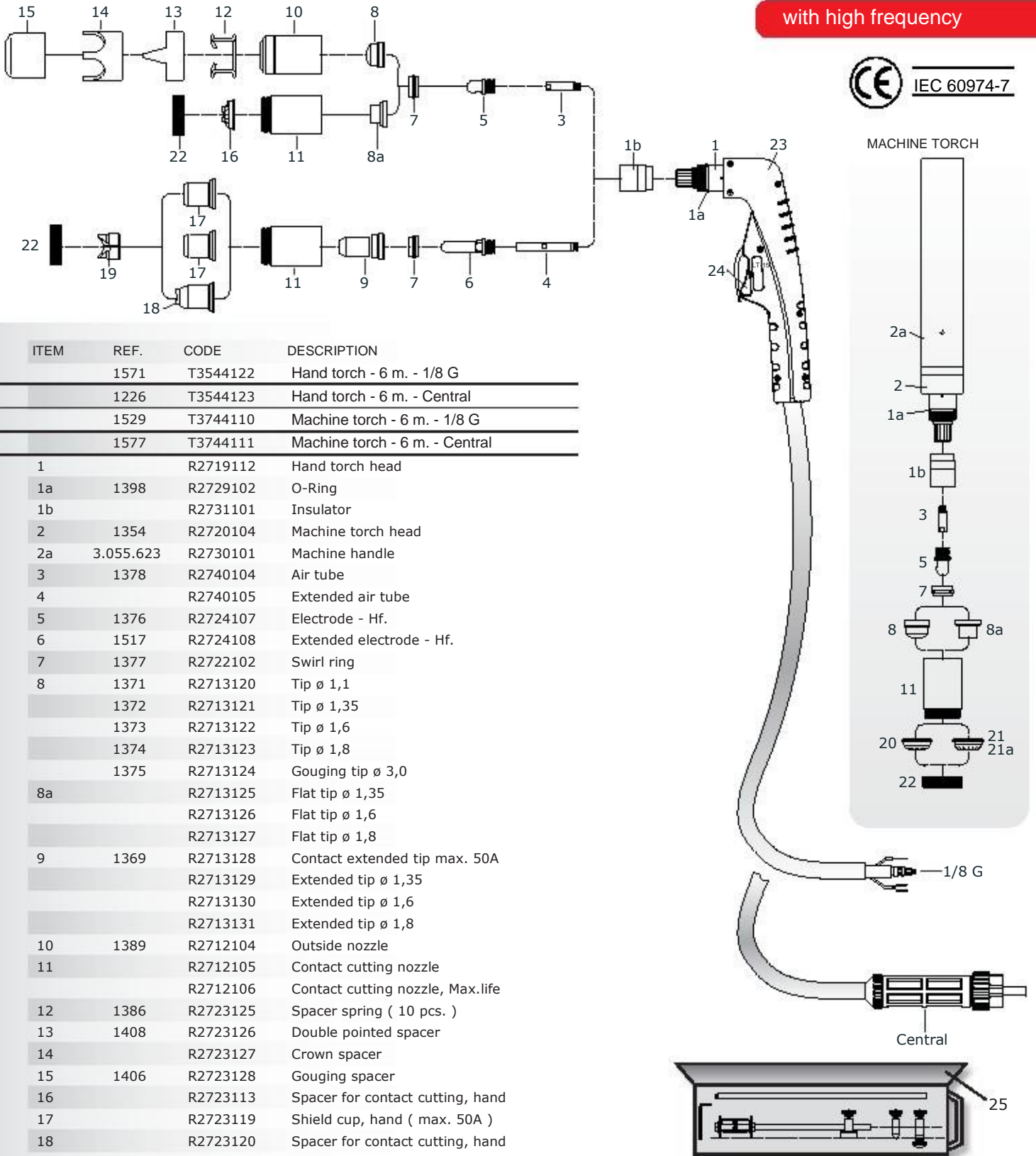

ITEM	REF.	CODE	DESCRIPTION
	1571	T3544122	Hand torch - 6 m. - 1/8 G
	1226	T3544123	Hand torch - 6 m. - Central
	1529	T3744110	Machine torch - 6 m. - 1/8 G
	1577	T3744111	Machine torch - 6 m. - Central
1		R2719112	Hand torch head
1a	1398	R2729102	O-Ring
1b		R2731101	Insulator
2	1354	R2720104	Machine torch head
2a	3.055.623	R2730101	Machine handle
3	1378	R2740104	Air tube
4		R2740105	Extended air tube
5	1376	R2724107	Electrode - Hf.
6	1517	R2724108	Extended electrode - Hf.
7	1377	R2722102	Swirl ring
8	1371	R2713120	Tip \varnothing 1,1
	1372	R2713121	Tip \varnothing 1,35
	1373	R2713122	Tip \varnothing 1,6
	1374	R2713123	Tip \varnothing 1,8
	1375	R2713124	Gouging tip \varnothing 3,0
8a		R2713125	Flat tip \varnothing 1,35
		R2713126	Flat tip \varnothing 1,6
		R2713127	Flat tip \varnothing 1,8
9	1369	R2713128	Contact extended tip max. 50A
		R2713129	Extended tip \varnothing 1,35
		R2713130	Extended tip \varnothing 1,6
		R2713131	Extended tip \varnothing 1,8
10	1389	R2712104	Outside nozzle
11		R2712105	Contact cutting nozzle
		R2712106	Contact cutting nozzle, Max.life
12	1386	R2723125	Spacer spring (10 pcs.)
13	1408	R2723126	Double pointed spacer
14		R2723127	Crown spacer
15	1406	R2723128	Gouging spacer
16		R2723113	Spacer for contact cutting, hand
17		R2723119	Shield cup, hand (max. 50A)
18		R2723120	Spacer for contact cutting, hand
19		R2723121	Spacer for extended tips High Amp.
20		R2723116	Shield cup, machine
21		R2723117	Shield cup, machine
21a		R2723118	Shield cup, machine
22		R2723122	Locking nut
23		R2730105	Handle
24		R4932102	Trigger
25		R4616102	Circle cutting attachment
	1509	R2740106	Extractor for swirl ring

RMT Ltd. is in no way affiliated with CEBORA®. The parts advertised for sale are not genuine CEBORA® parts, but are parts made for RMT Ltd. Reference to CEBORA® torches and numbers are for your convenience only. We reserve the right to substitute genuine CEBORA® parts in place of RMT Ltd. parts.



IEC 60974-7

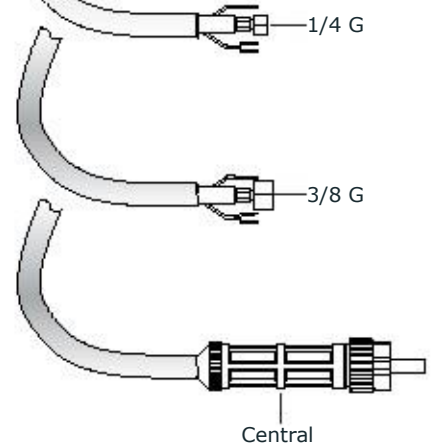
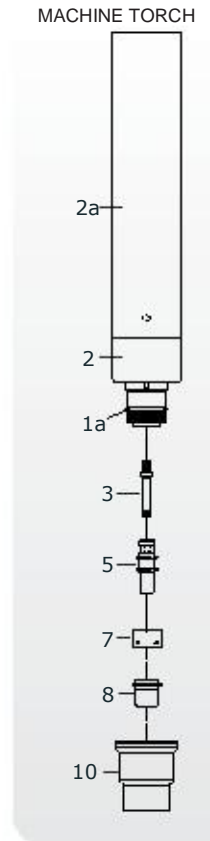
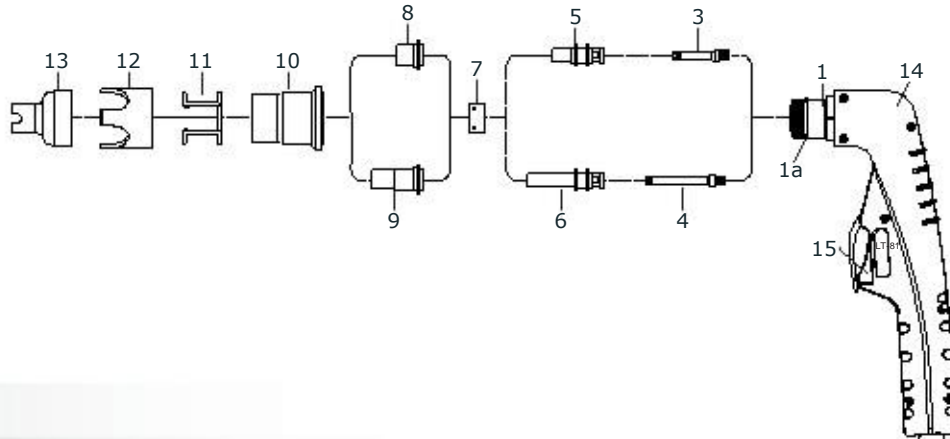

ITEM	REF.	CODE	DESCRIPTION
	PA1404	T3576119	Hand torch - 6 m. - 1/4 G
	PA1400	T3576111	Hand torch - 6 m. - 3/8 G
	PA1402	T3576112	Hand torch - 6 m. - Central
	PA0180	T3776101	Machine torch - 6 m. - 3/8 G
	PA0181	T3776102	Machine torch - 6 m. - Central
1		R4619105	Hand torch head
1a	EA0125	R4629101	O-Ring
2	PF0120	R4620101	Machine torch head
2a	TP0061	R4630101	Machine handle
3	FH0560	R4640101	Air tube
4	FH0561	R4640102	Extended air tube
5	PR0109	R4624104	Electrode
6	PR0115	R4624105	Extended electrode
7	PE0107	R4622102	Swirl ring
8	PD0105-10	R4613107	Tip 1.0
	PD0105-11	R4613108	Tip 1.1
	PD0105-12	R4613109	Tip 1.2
9	PD0106-10	R4613110	Extended tip 1.0
	PD0106-12	R4613111	Extended tip 1.2
10	PC0115	R4612103	Nozzle retaining cap
11	CV0028	R2623101	Spacer spring (10 pcs.)
12	CV0033	R4623102	Crown spacer
13	CV0201	R4623100	Spacer for contact cutting
14		R2730105	Handle
15		R4932102	Trigger
16	CV0052	R4616104	Circle cutting attachment

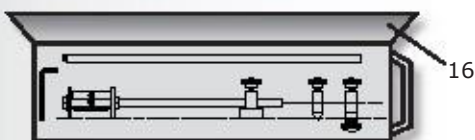

RMT Ltd. is in no way affiliated with TRAFIMET®. The parts advertised for sale are not genuine TRAFIMET® parts, but are parts made for RMT Ltd. Reference to TRAFIMET® torches and numbers are for your convenience only. We reserve the right to substitute genuine TRAFIMET® parts in place of RMT Ltd. parts.



IEC 60974-7

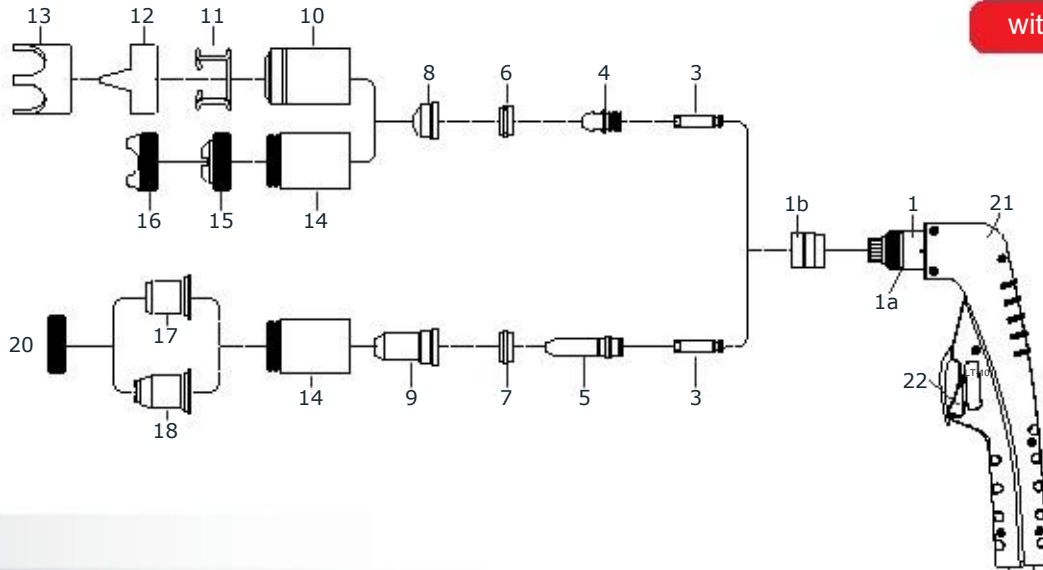

MACHINE TORCH

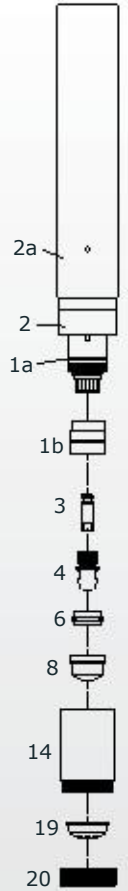

ITEM	REF.	CODE	DESCRIPTION
	PA1450	T3576113	Hand torch - 6 m. - M14X1
	PA1452	T3576114	Hand torch - 6 m. - Central
	PA0110	T3776103	Machine torch - 6 m. - M14X1
	PA0111	T3776104	Machine torch - 6 m. - Central
1		R4619109	Hand torch head
1a		R4629102	O-Ring
1b		R4631101	Front insulator
2	PF0115	R4620102	Machine torch head
2a		R2730101	Machine handle
3		R4640103	Air tube
4	PR0101	R4624106	Electrode
5	PR0116	R4624107	Extended electrode
6	PE0101	R4622103	Swirl ring
7	PE0103	R4631102	Insulating spacer
8	PD0101-11	R4613112	Tip \varnothing 1.0
	PD0101-14	R4613113	Tip \varnothing 1.4
	PD0101-17	R4613114	Tip \varnothing 1.7
9	PD0111	R4613115	Extended tip 50 A max - to use with pos. 17+20
	PD0117-14	R4613116	Extended tip 1.4 - to use with pos. 18+20
	PD0117-17	R4613117	Extended tip 1.7 - to use with pos. 18+20
10	PC0111	R4612104	Outside nozzle
11	CV0011	R4623112	Spacer spring (10 pcs.)
12	CV0012	R4623113	Double pointed spacer
13	CV0014	R4623114	Crown spacer
14	PC0130	R4612105	Contact nozzle retaining cap,
		R4612106	Contact nozzle retaining cap, Max.life
15	CV0023	R4623103	Spacer for contact cutting
16	CV0039	R4623104	Large spacer for contact cutting
17	CV0008	R4623109	Shield cup, hand (max. 50A)
18	CV0009	R4623110	Spacer for contact cutting, hand
19		R4623108	Shield cup, machine
20		R4623111	Locking nut
21		R2730105	Handle
22		R4932102	Trigger
23	CV0022	R4616102	Circle cutting attachment
	GR0060	R2740106	Extractor for swirl ring

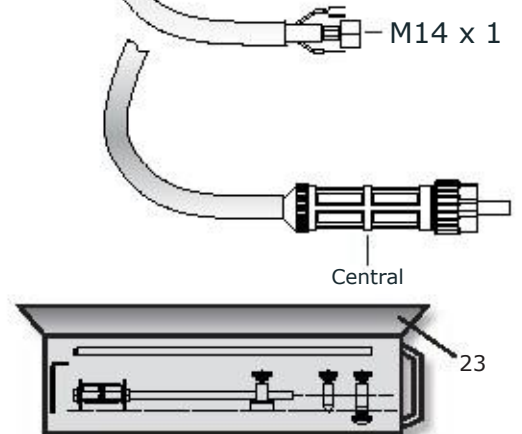

RMT Ltd. is in no way affiliated with TRAFIMET®. The parts advertised for sale are not genuine TRAFIMET® parts, but are parts made for RMT Ltd. Reference to TRAFIMET® torches and numbers are for your convenience only. We reserve the right to substitute genuine TRAFIMET® parts in place of RMT Ltd. parts.



IEC 60974-7

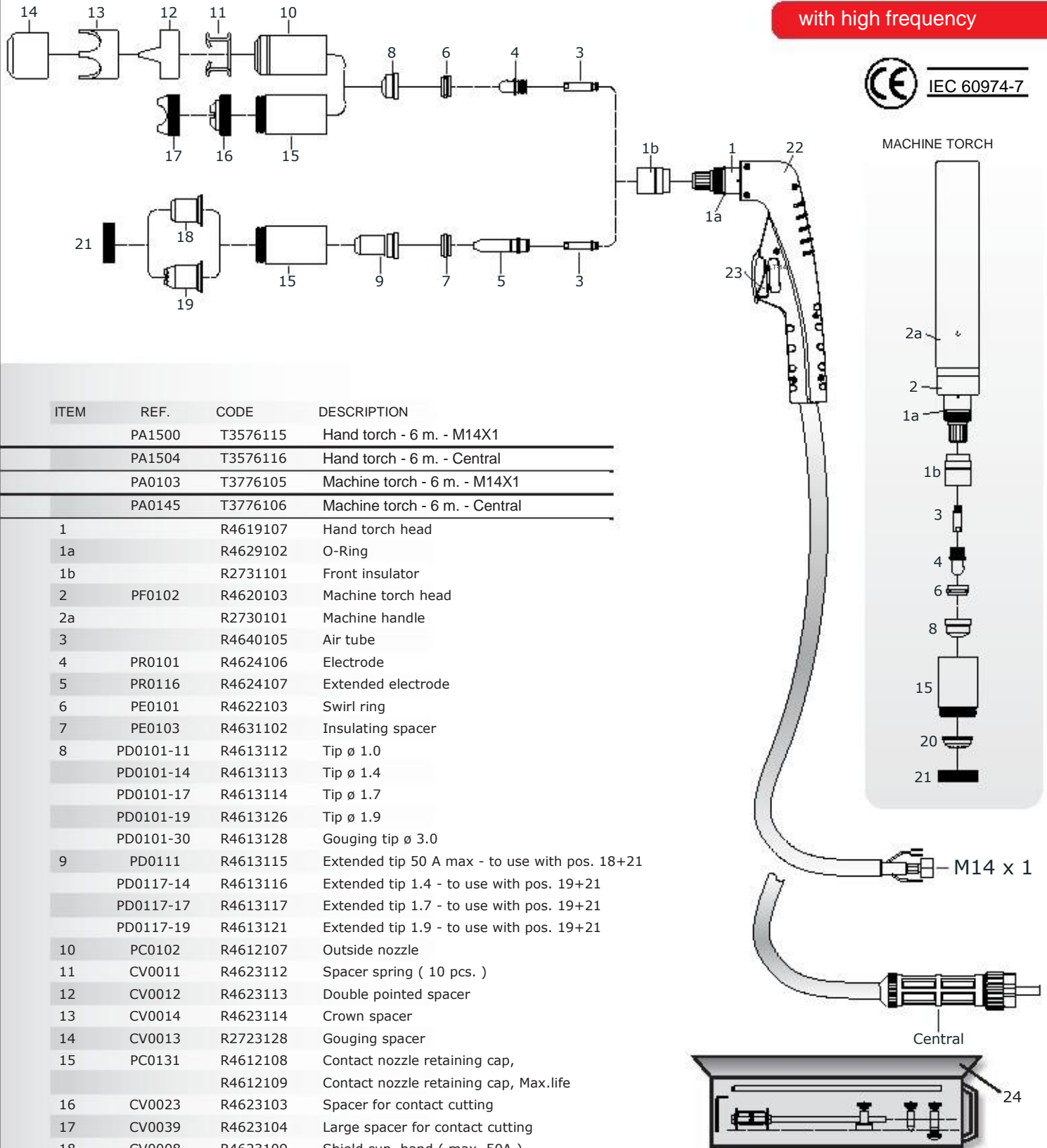

ITEM	REF.	CODE	DESCRIPTION
	PA1500	T3576115	Hand torch - 6 m. - M14X1
	PA1504	T3576116	Hand torch - 6 m. - Central
	PA0103	T3776105	Machine torch - 6 m. - M14X1
	PA0145	T3776106	Machine torch - 6 m. - Central
1		R4619107	Hand torch head
1a		R4629102	O-Ring
1b		R2731101	Front insulator
2	PF0102	R4620103	Machine torch head
2a		R2730101	Machine handle
3		R4640105	Air tube
4	PR0101	R4624106	Electrode
5	PR0116	R4624107	Extended electrode
6	PE0101	R4622103	Swirl ring
7	PE0103	R4631102	Insulating spacer
8	PD0101-11	R4613112	Tip \varnothing 1.0
	PD0101-14	R4613113	Tip \varnothing 1.4
	PD0101-17	R4613114	Tip \varnothing 1.7
	PD0101-19	R4613126	Tip \varnothing 1.9
	PD0101-30	R4613128	Gouging tip \varnothing 3.0
9	PD0111	R4613115	Extended tip 50 A max - to use with pos. 18+21
	PD0117-14	R4613116	Extended tip 1.4 - to use with pos. 19+21
	PD0117-17	R4613117	Extended tip 1.7 - to use with pos. 19+21
	PD0117-19	R4613121	Extended tip 1.9 - to use with pos. 19+21
10	PC0102	R4612107	Outside nozzle
11	CV0011	R4623112	Spacer spring (10 pcs.)
12	CV0012	R4623113	Double pointed spacer
13	CV0014	R4623114	Crown spacer
14	CV0013	R2723128	Gouging spacer
15	PC0131	R4612108	Contact nozzle retaining cap,
		R4612109	Contact nozzle retaining cap, Max.life
16	CV0023	R4623103	Spacer for contact cutting
17	CV0039	R4623104	Large spacer for contact cutting
18	CV0008	R4623109	Shield cup, hand (max. 50A)
19	CV0009	R4623110	Spacer for contact cutting, hand
20		R4623108	Shield cup, machine
21		R4623111	Locking nut
22		R2730105	Handle
23		R4932102	Trigger
24	CV0022	R4616102	Circle cutting attachment
	GR0060	R2740106	Extractor for swirl ring

RMT Ltd. is in no way affiliated with TRAFIMET®. The parts advertised for sale are not genuine TRAFIMET® parts, but are parts made for RMT Ltd. Reference to TRAFIMET® torches and numbers are for your convenience only. We reserve the right to substitute genuine TRAFIMET® parts in place of RMT Ltd. parts.

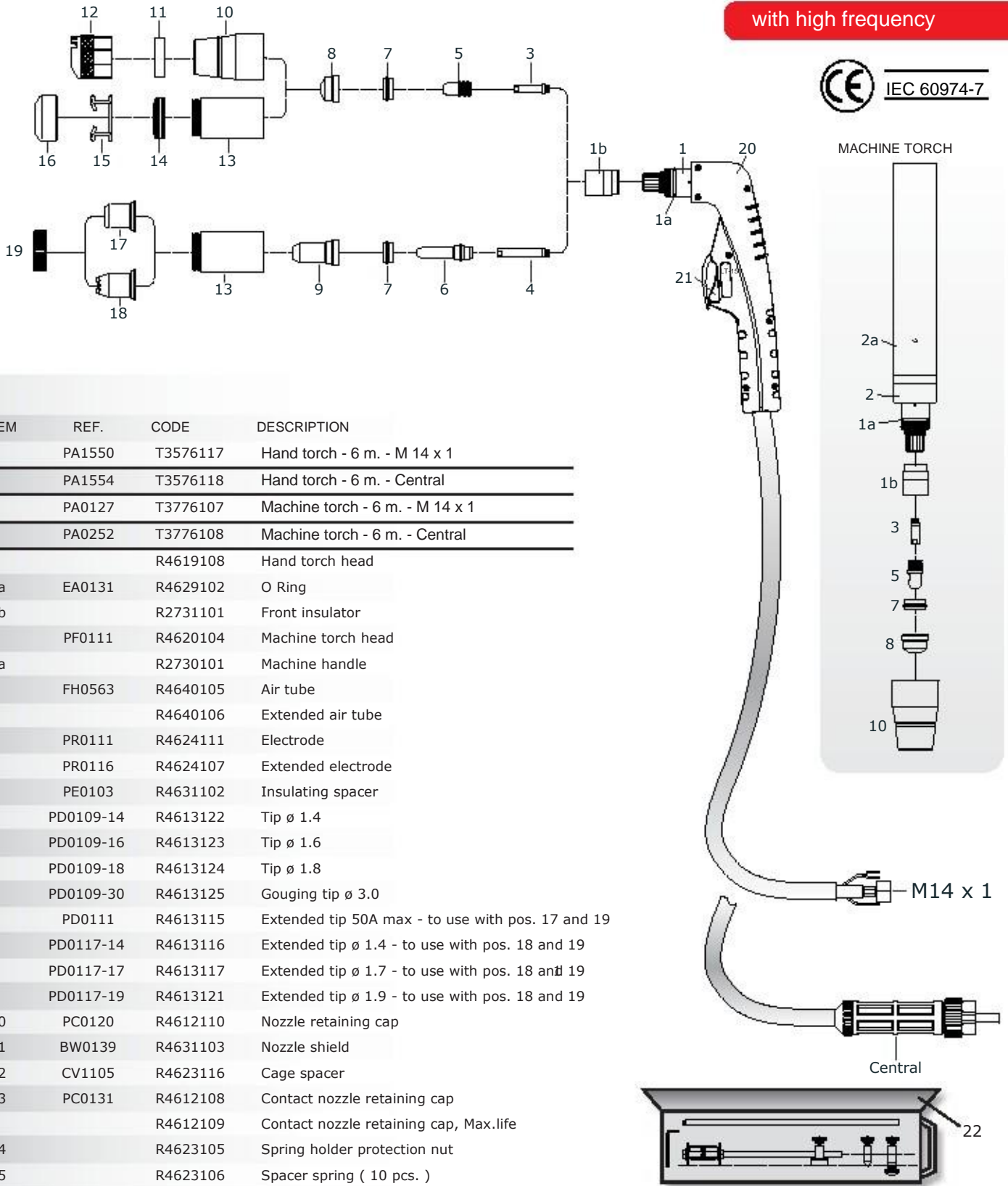

ITEM	REF.	CODE	DESCRIPTION
	PA1550	T3576117	Hand torch - 6 m. - M 14 x 1
	PA1554	T3576118	Hand torch - 6 m. - Central
	PA0127	T3776107	Machine torch - 6 m. - M 14 x 1
	PA0252	T3776108	Machine torch - 6 m. - Central
1		R4619108	Hand torch head
1a	EA0131	R4629102	O Ring
1b		R2731101	Front insulator
2	PF0111	R4620104	Machine torch head
2a		R2730101	Machine handle
3	FH0563	R4640105	Air tube
4		R4640106	Extended air tube
5	PR0111	R4624111	Electrode
6	PR0116	R4624107	Extended electrode
7	PE0103	R4631102	Insulating spacer
8	PD0109-14	R4613122	Tip \varnothing 1.4
	PD0109-16	R4613123	Tip \varnothing 1.6
	PD0109-18	R4613124	Tip \varnothing 1.8
	PD0109-30	R4613125	Gouging tip \varnothing 3.0
9	PD0111	R4613115	Extended tip 50A max - to use with pos. 17 and 19
	PD0117-14	R4613116	Extended tip \varnothing 1.4 - to use with pos. 18 and 19
	PD0117-17	R4613117	Extended tip \varnothing 1.7 - to use with pos. 18 and 19
	PD0117-19	R4613121	Extended tip \varnothing 1.9 - to use with pos. 18 and 19
10	PC0120	R4612110	Nozzle retaining cap
11	BW0139	R4631103	Nozzle shield
12	CV1105	R4623116	Cage spacer
13	PC0131	R4612108	Contact nozzle retaining cap
		R4612109	Contact nozzle retaining cap, Max.life
14		R4623105	Spring holder protection nut
15		R4623106	Spacer spring (10 pcs.)
16		R4623115	Gauging spacer
17	CV0008	R4623109	Shield cup, hand (tip max. 50A)
18	CV0009	R4623110	Spacer for contact cutting, hand
19		R4623111	Locking nut
20		R2730105	Handle
21		R4932102	Trigger
22	CV0022	R4616102	Circle cutting attachment

RMT Ltd. is in no way affiliated with TRAFIMET®. The parts advertised for sale are not genuine TRAFIMET® parts, but are parts made for RMT Ltd. Reference to TRAFIMET® torches and numbers are for your convenience only. We reserve the right to substitute genuine TRAFIMET® parts in place of RMT Ltd. parts.